

Active target data analysis

The active target MAYA

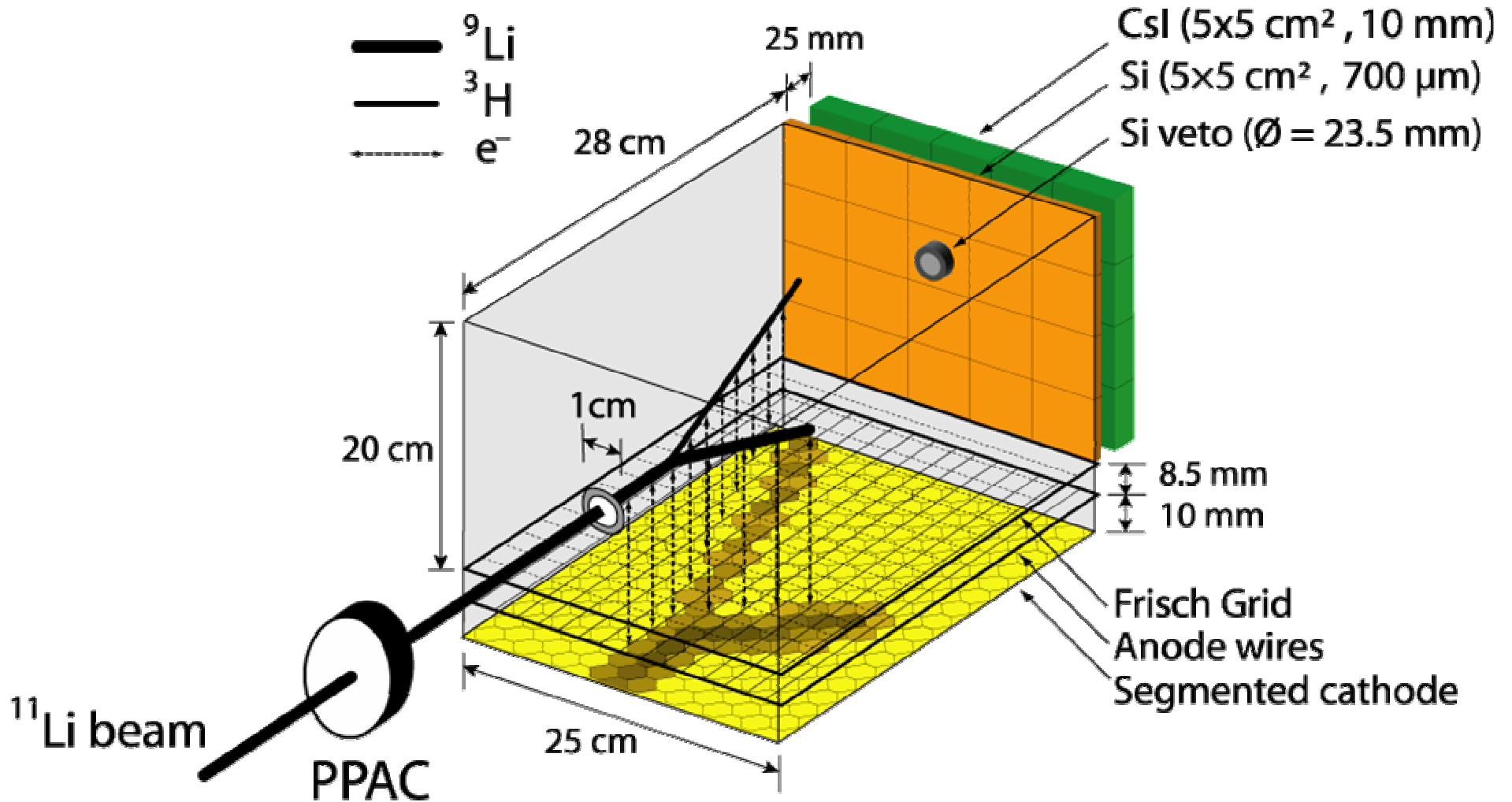

The active target MAYA

A two dimensional charge – one dimensional time projection chamber

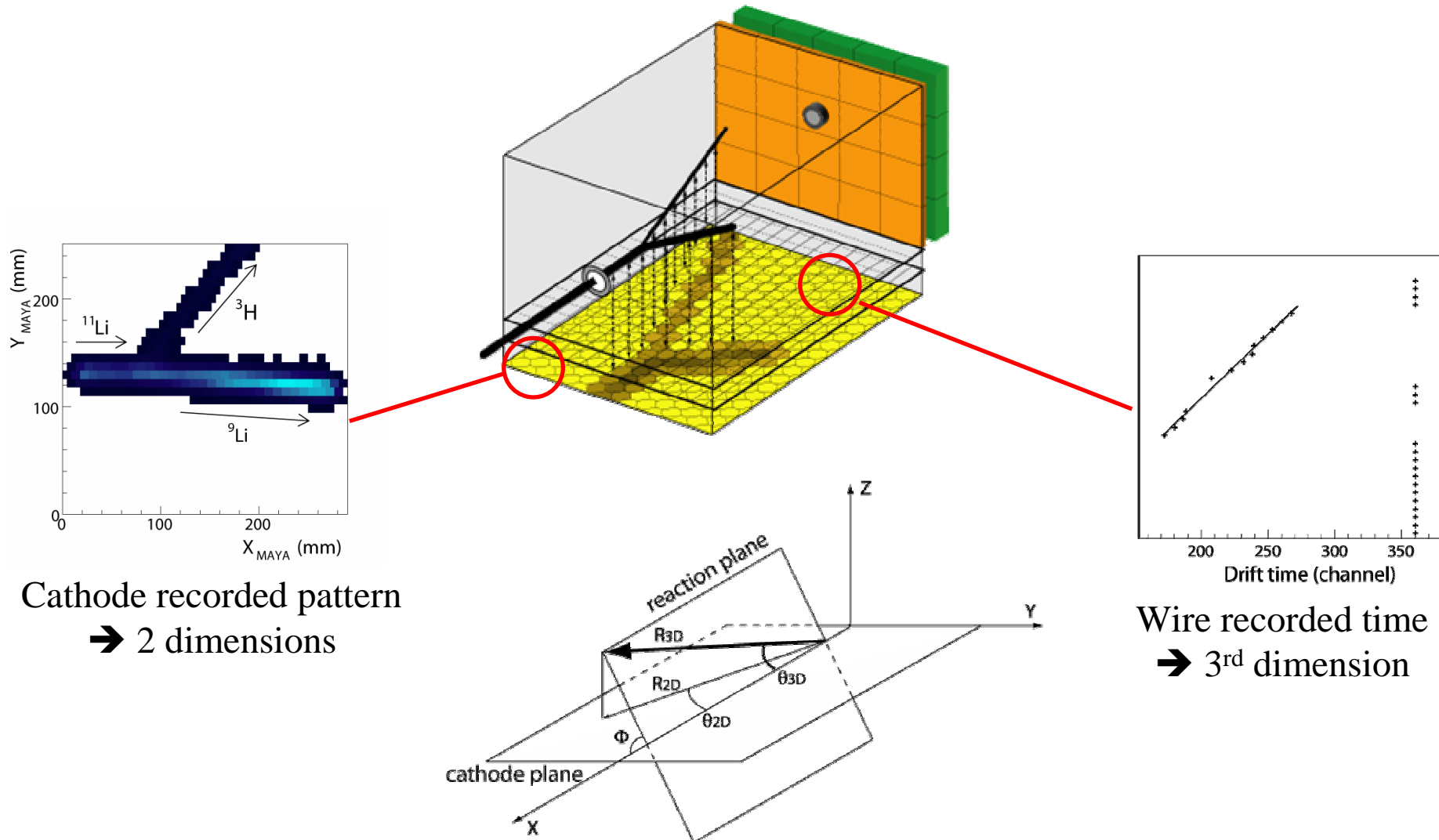

Cathode recorded pattern
 → 2 dimensions

Wire recorded time
 → 3rd dimension

PADS calibration with pulser

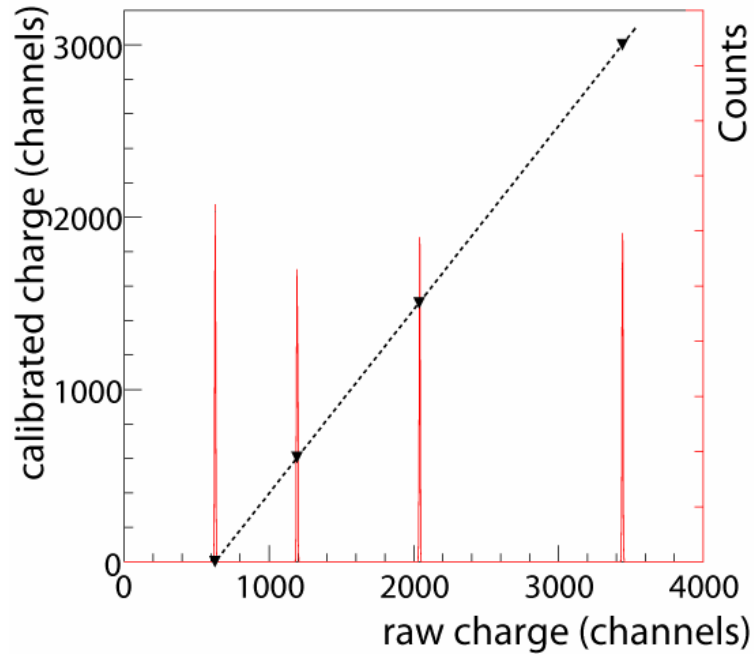

Dynamic : 90%

Resolution : < 0.5%

Time calibration with pulser

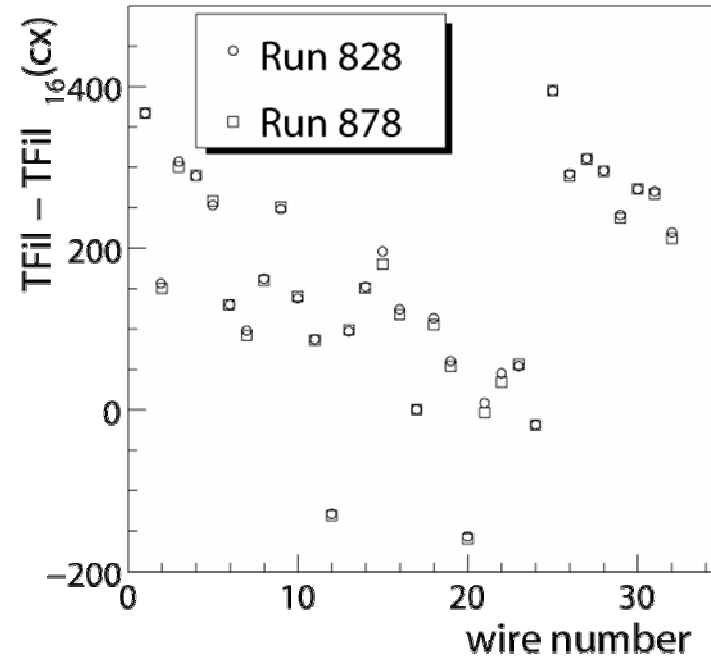

Good stability

Resolution : < 5%

Light + high E → Si / CsI

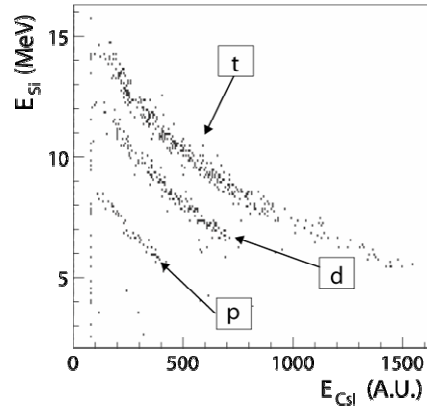

Good resolution
 Calibration of CsI?

Medium E → PADS / Si

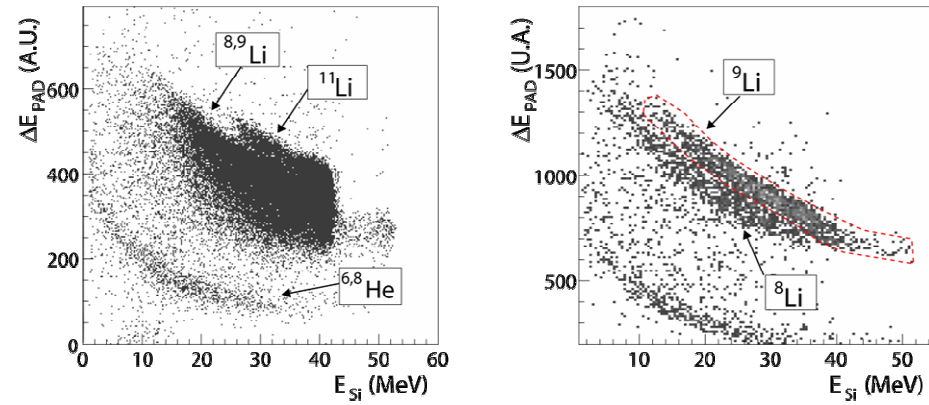

ΔE resolution - Dynamics ?
 Absolute calibration of charge ?

Low E → Range / ΔE

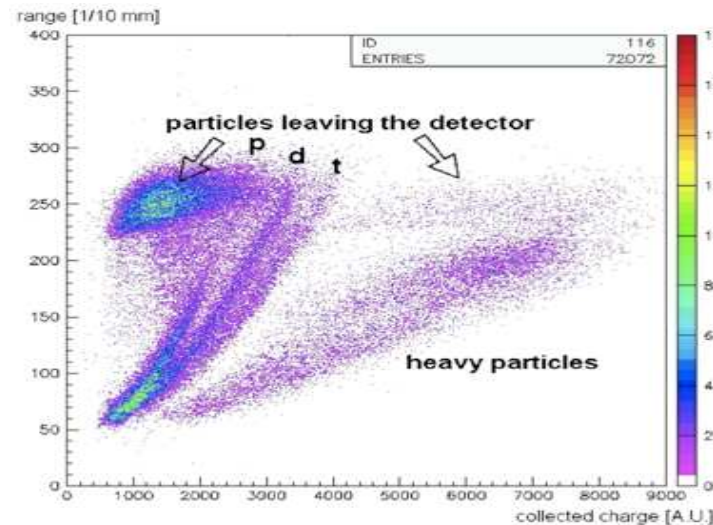

Range resolution?
 ΔE resolution - Dynamics ?

→ Distribution induced by a point source

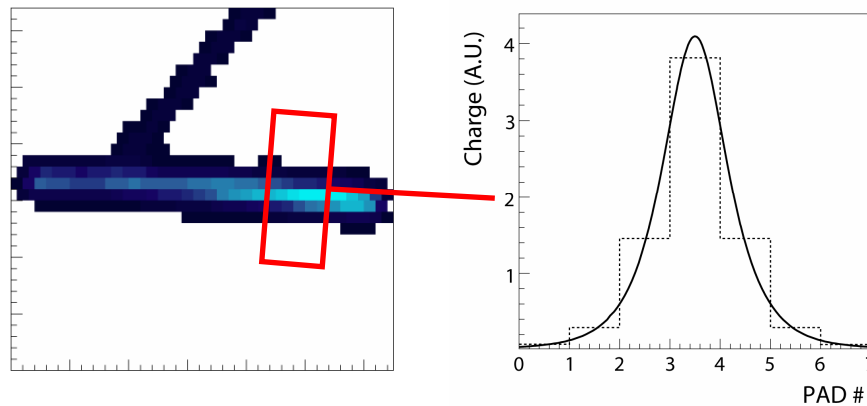

$$\sigma(x, y) = \frac{-Q}{2\pi} \sum_{n=0}^{\infty} \frac{(-1)^n (2n+1)L}{[(2n+1)^2 L^2 + x^2 + y^2]^{3/2}}$$

$$\Delta_R = \frac{w}{2} \frac{\ln\left(\frac{1+a_1}{1-a_1}\right)}{\ln(a_2 + \sqrt{a_2^2 - 1})}$$

$$a_1 = \frac{\sqrt{\frac{Q_0}{Q_+}} - \sqrt{\frac{Q_0}{Q_-}}}{2 \sinh a_2} \quad \text{and} \quad a_2 = \frac{1}{2} \left(\sqrt{\frac{Q_0}{Q_+}} + \sqrt{\frac{Q_0}{Q_-}} \right)$$

→ Search of the most perpendicular axis

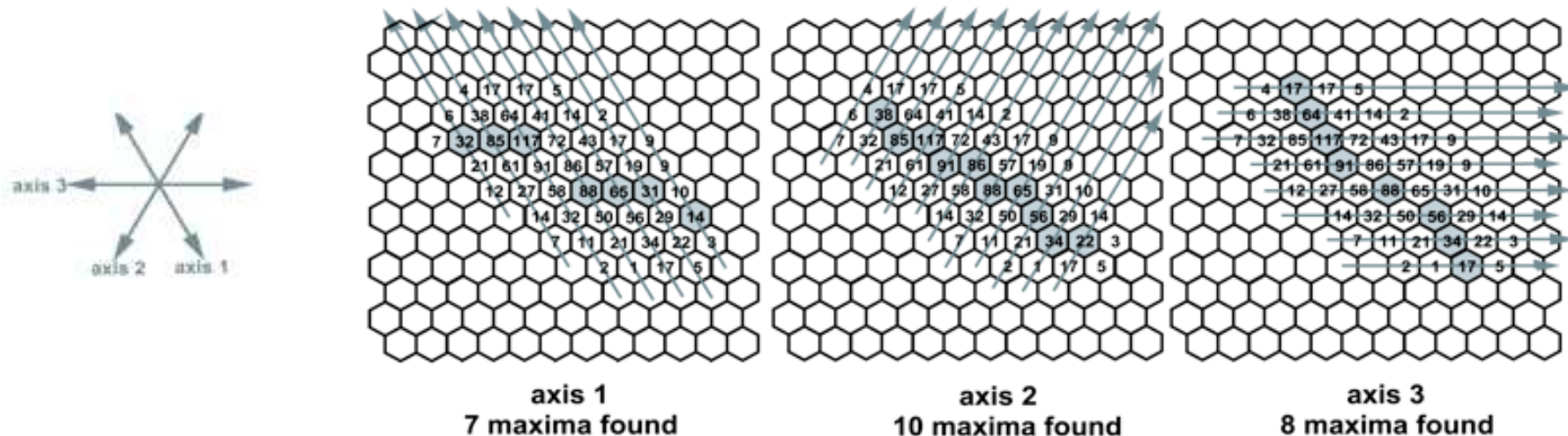

Calculated angle
 shifted around 0° and 60°

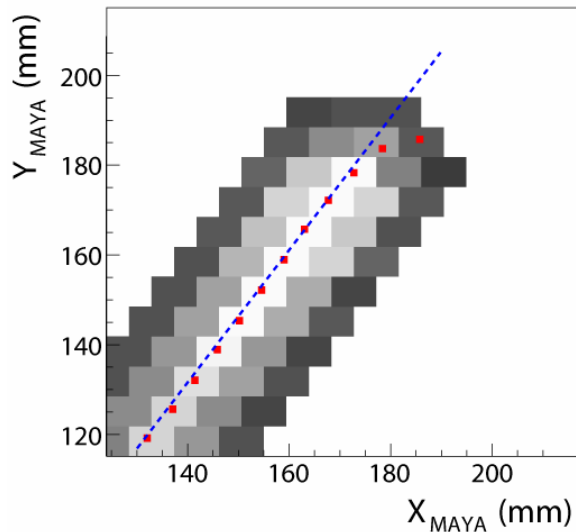
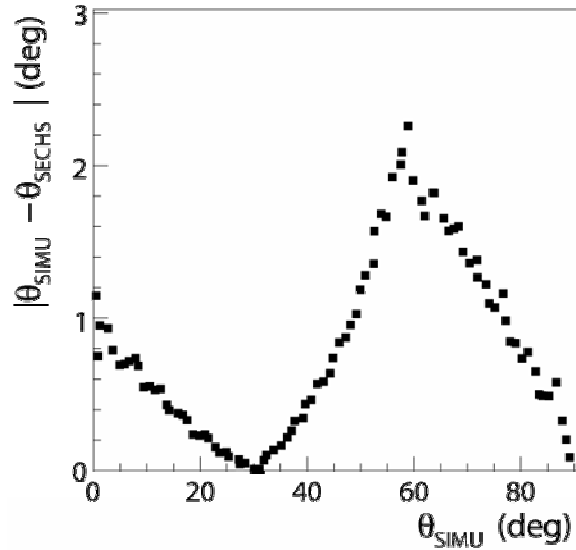

Effect disappear
 when removing last points

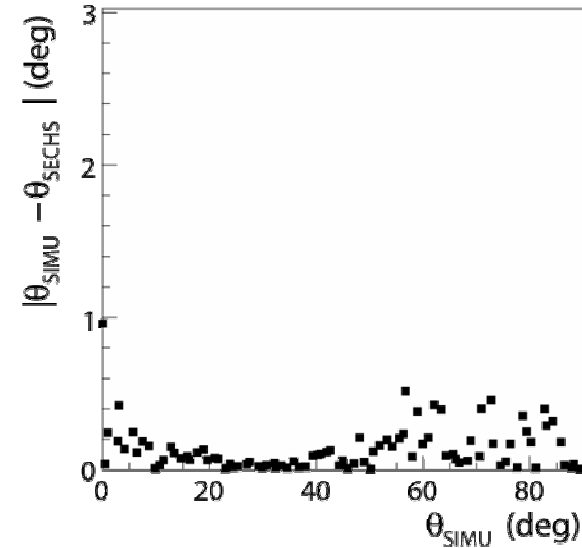

Resolution $< 0.5^\circ$

BUT:

Range has to be > 4 PADS!

Thickness of the track !

➔ PAD size could help

→ Orthogonal distance regression

$$\chi^2 = \sum_{n=0}^{N_{pts}} Q_n \frac{(ax_n + b - y_n)^2}{a^2 + 1}$$

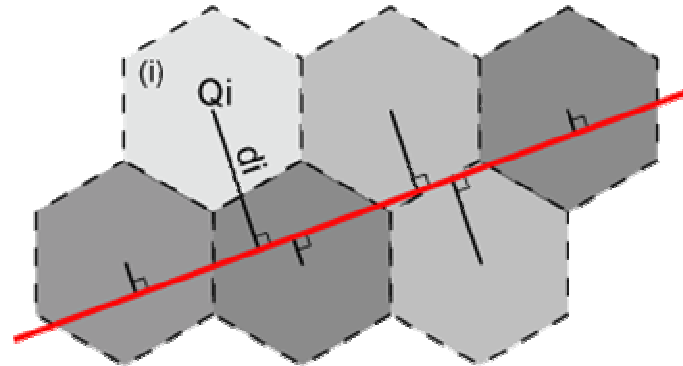

One track

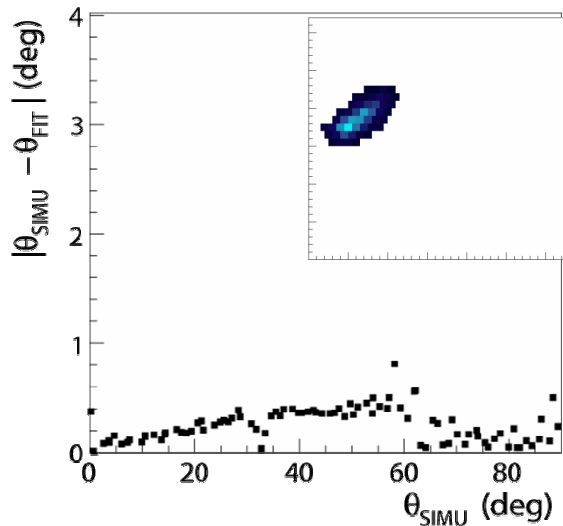

Resolution reaches 0.5°
 Range > thickness (3 PADS)

Multiple tracks

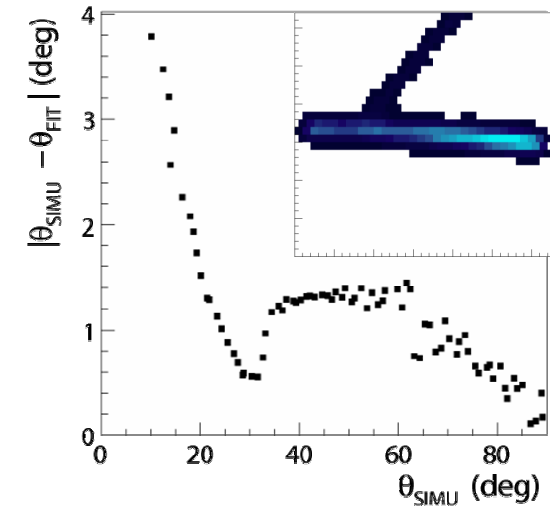
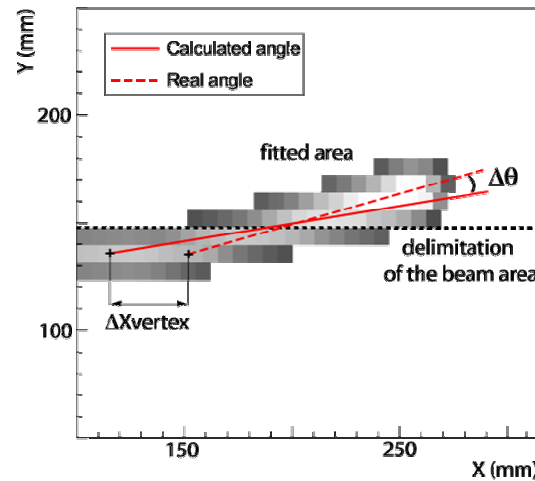

Resolution > 1°
 PAD size could help... (image processing)

Intersection point method

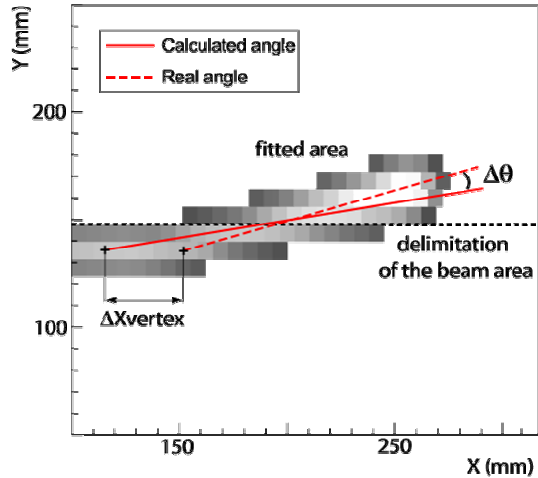

angles $> 30^\circ$
 \rightarrow Resolution < 2 mm

Small angles
 \rightarrow Resolution > 8 mm

Charge profile method

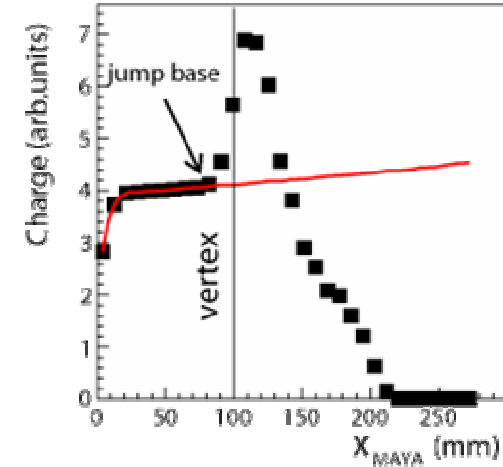
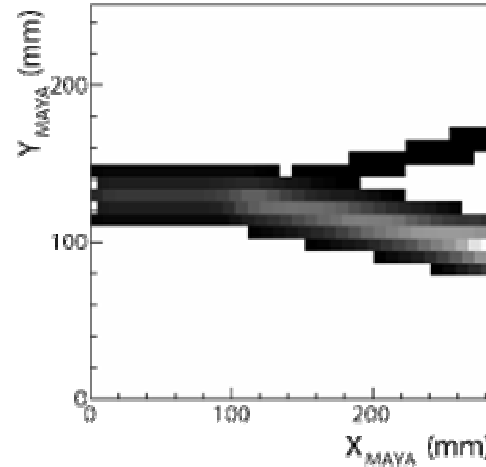
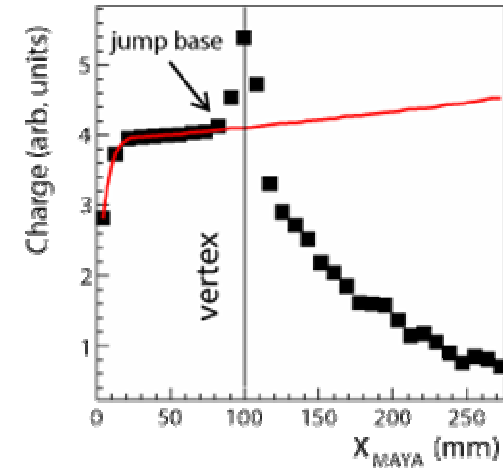
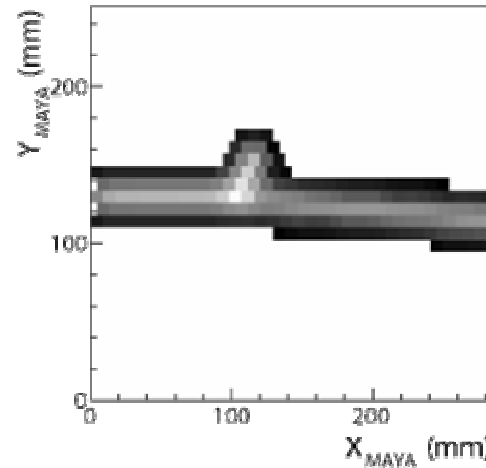

Resolution : 1 PAD

Better if good charge resolution

Range measurements : Ending point

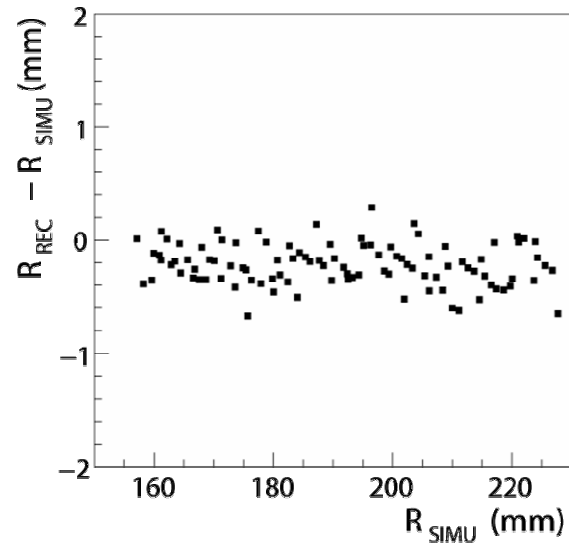
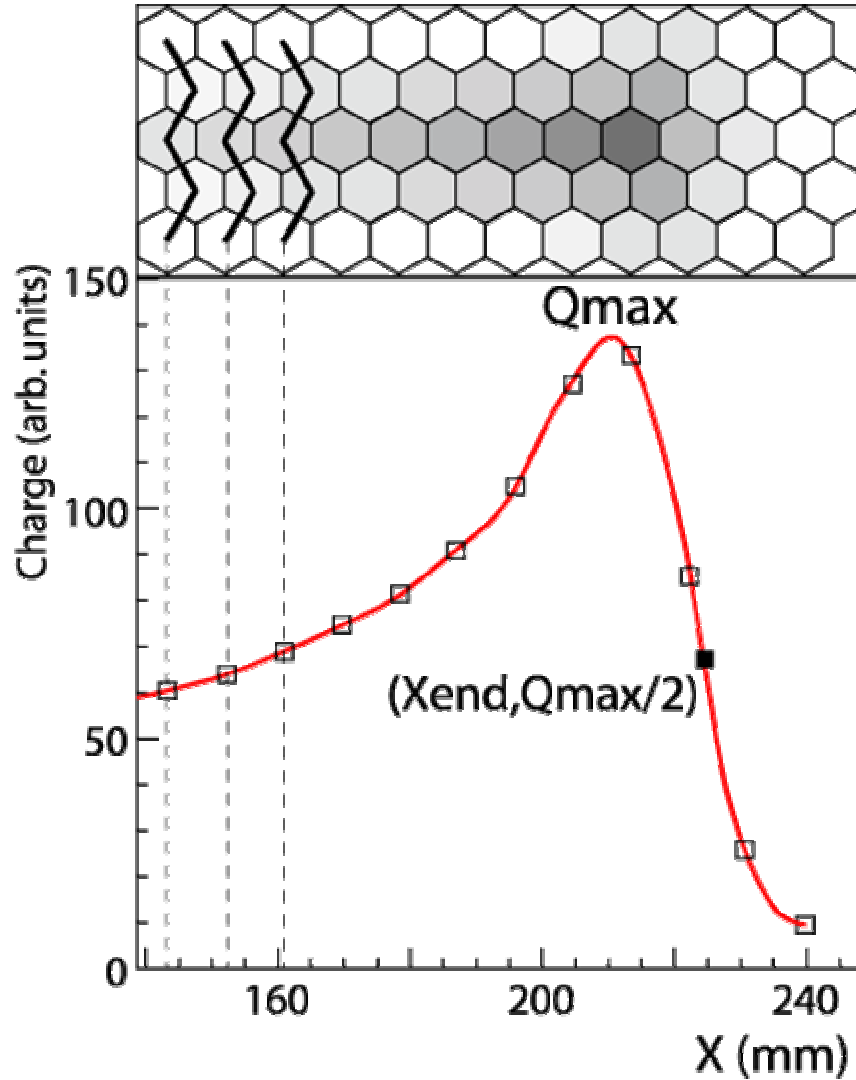

No threshold :
 Resolution < 0.5 mm

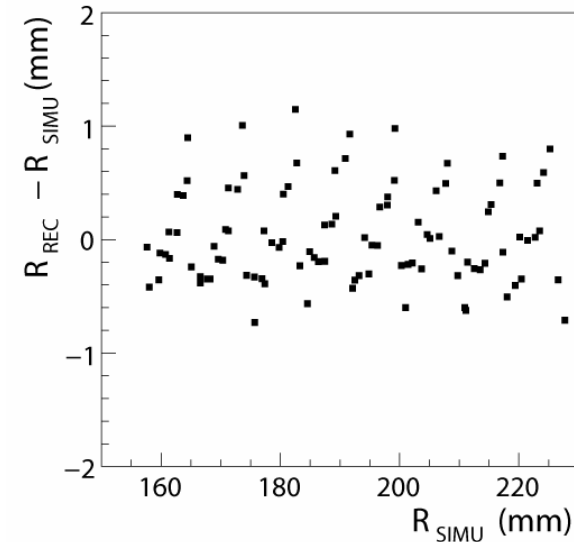

10% threshold :
 Resolution > 1.5 mm
 + digitalization!!

Lower threshold
 needed!!!

Drift velocity calibration
 → using physics!

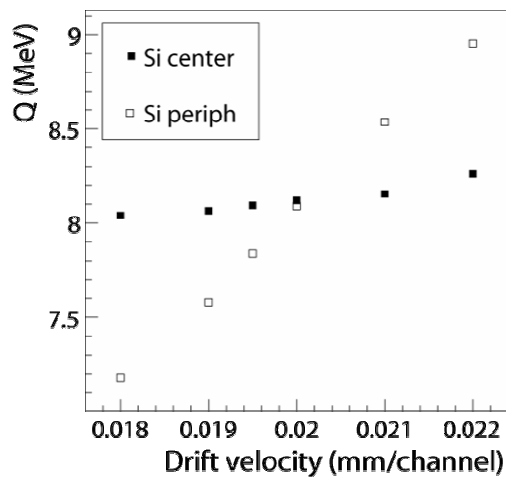
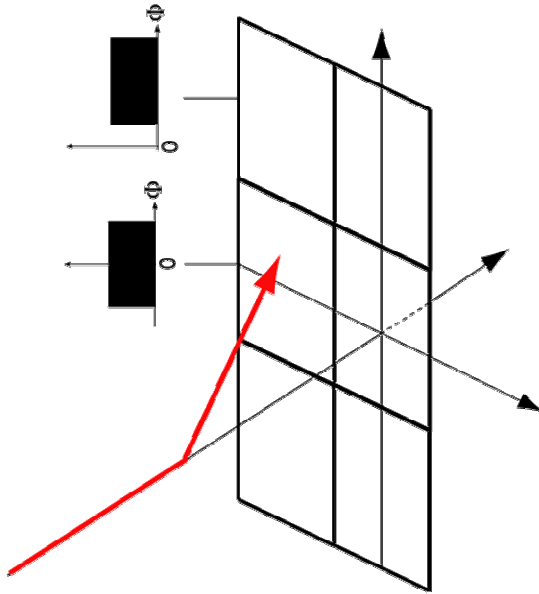

Reaction plane angle

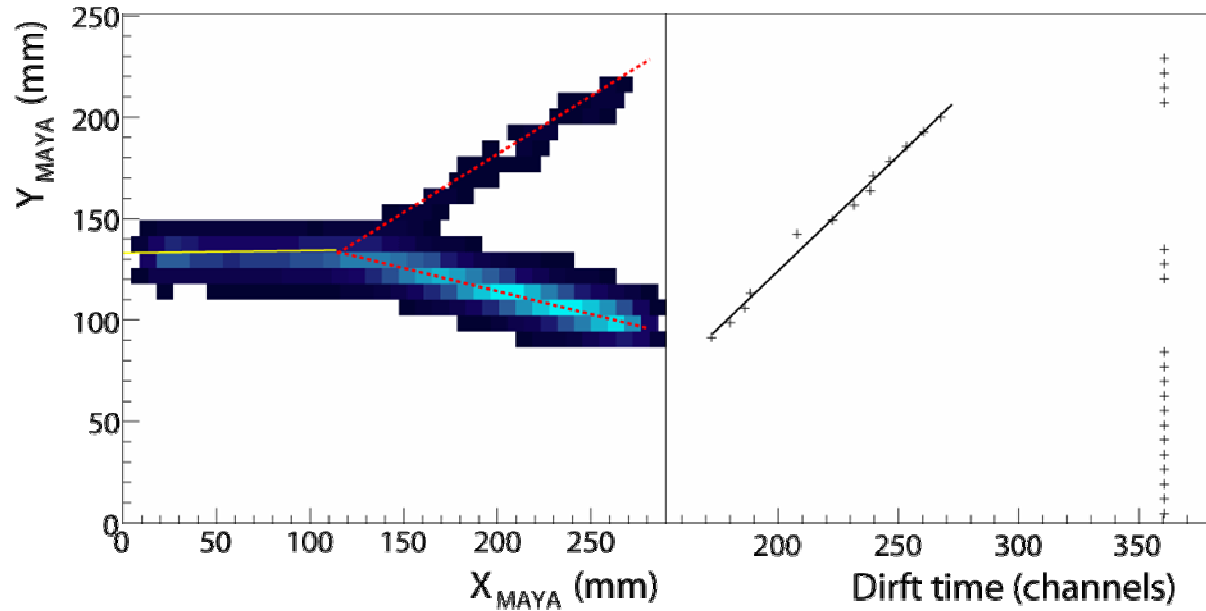

Resolution $> 3^\circ$

Requires at least 2 wires

→ Limitation : $|\Phi| < 60^\circ$

Solutions :

- more wires
- time signal from pads

Observable	Resolution	Difficulties	Solutions...
ΔE_{PAD}	> 1 au	Dynamics No absolute calibration	Better charge resolution Increase dynamics
θ_{2D}	~ 1°	Thickness of the track Range of particles	Smaller pad size Increase dynamics
ϕ	> 3°	Number of wires/points	More wires – time signal on pads
Range	~ 1.5 mm	Influence of the threshold	Lower threshold